

# DOMINO

The lightweight panel formwork for building construction and civil engineering

Product Brochure – Issue 01/2015

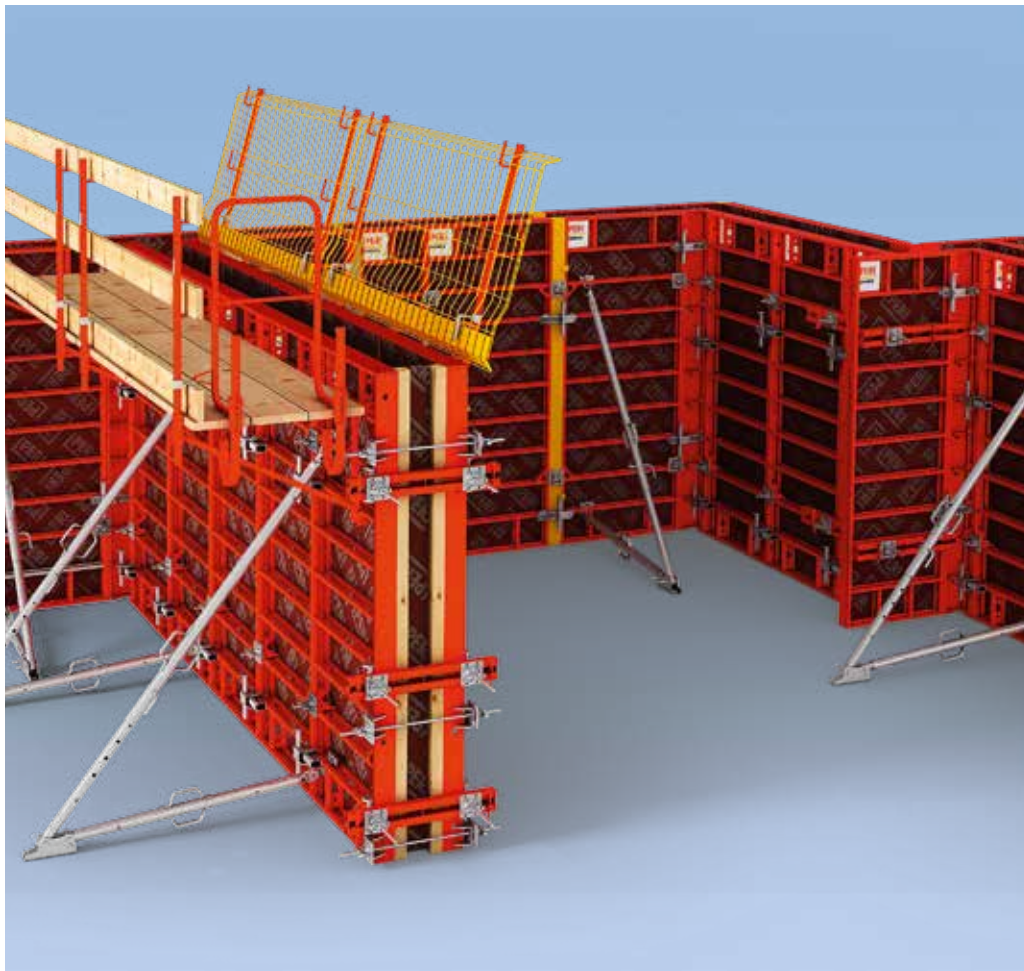

# Inhalt

## System Advantages

- 4 DOMINO**  
The lightweight panel formwork for building construction and civil engineering
- 6 Lightweight**  
Low dead weight and only 5 panel widths
- 9 Simple**  
One component for virtually all connections – the Alignment Coupler DRS
- 10 Practical**  
Inset tie points and a comprehensive range of accessories for fast working operations in all situations

## Standard Applications

- 12 DOMINO standard applications**  
Corners, T-junctions and fillers can easily be realised within the system

**Edition 01/2015**

### **Publisher**

**PERI GmbH**  
**Formwork Scaffolding Engineering**  
Rudolf-Diesel-Strasse 19  
89264 Weissenhorn  
Germany  
info@peri.com  
www.peri.com

### **Important notes**

All current safety regulations and guidelines applicable in those countries where our products are used must be observed.

The photos shown in this brochure feature construction sites in progress. For this reason, safety and anchor details in particular cannot always be considered conclusive or final. These are subject to the risk assessment carried out by the contractor.

In addition, the computer graphics used are to be regarded as system representations. To facilitate understanding, these and the detailed illustrations shown have been partially reduced to certain aspects. The safety installations that are not

shown in these detailed descriptions must nevertheless be available. The systems or items shown might not be available in every country.

Safety instructions and load specifications are to be strictly observed at all times. Separate structural calculations are required for any deviations from the standard design data.

The information contained herein is subject to technical changes in the interests of progress. Errors and typographical mistakes reserved.

## DOMINO

The lightweight panel formwork for building construction and civil engineering

**With the DOMINO panel formwork, PERI has a robust and lightweight wall formwork in its programme which is ideal for building construction and civil engineering projects.**

With the appropriate frame, corner and stopend panels as well as compensations, a wide range of applications can be realised in the system.

The supplementary scaffold bracket is used to create safe working platforms. DOMINO frames are made of steel or aluminium.

All DOMINO system components can easily be moved into position without the use of a crane. The lightweight formwork is ideally suited for forming:

- foundations
- basement and storey-level walls
- beams
- swimming and adventure pools
- rectangular piers and columns
- parapets and retaining walls
- supply shafts and small traffic tunnels
- refurbishment projects

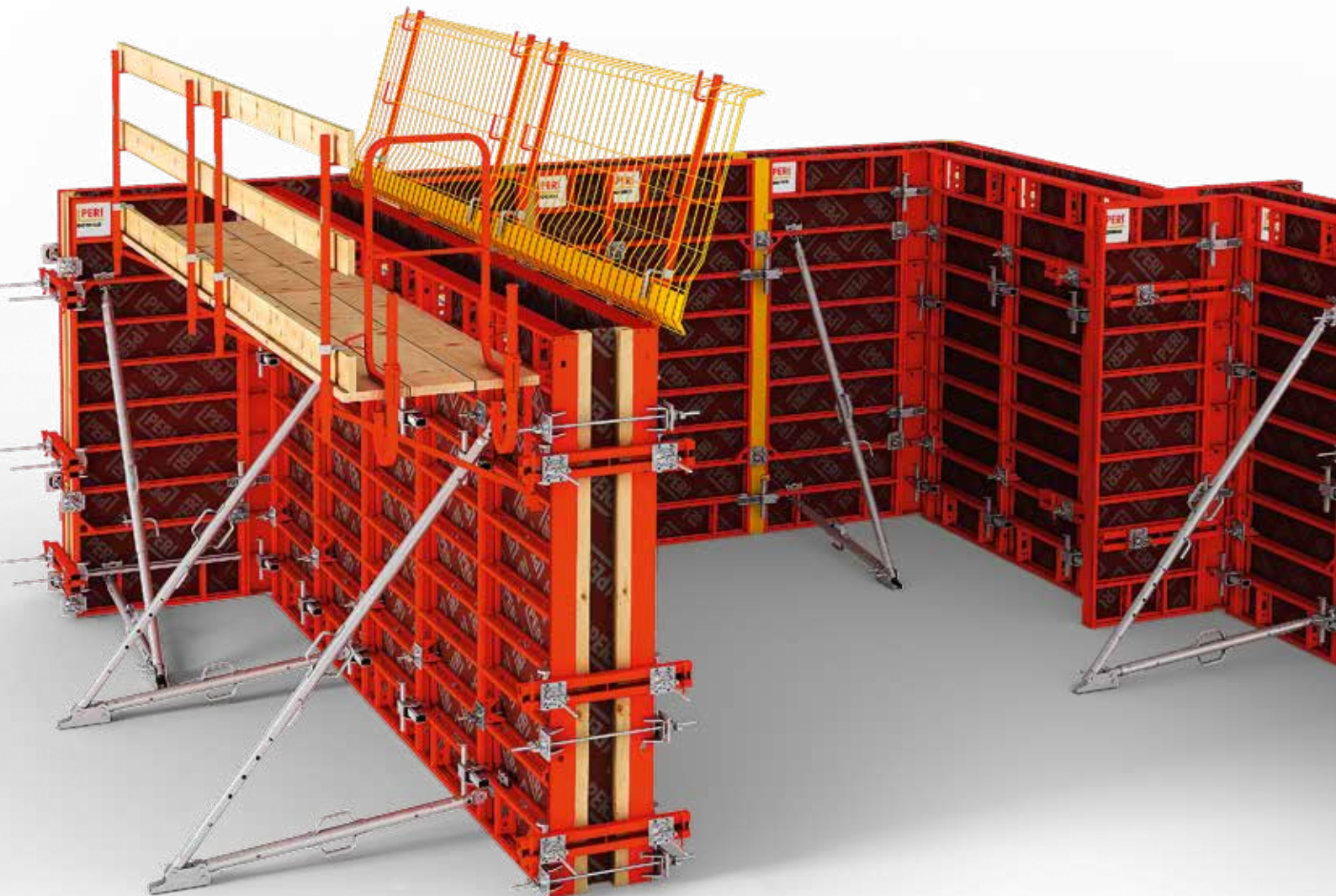



- **Lightweight**

Low dead weight, only 5 panel widths, also available with aluminum frames

- **Simple**

One component for virtually all connections – the Alignment Coupler DRS

- **Practical**

Inset tie points and a comprehensive range of accessories for fast working operations in all situations



- **Proven high quality**

For the production of the panel formwork, PERI places great importance on the highest possible resistance to mechanical stress and long service life of the components.

In the company's state-of-the-art powder coating plant, PERI achieves highly scratch-resistant, durable painted surfaces of the formwork frames. All elements are galvanized on the inside and have a closed frame profile. The integrated corner castings provide a high degree of rigidity of the formwork elements.

- **Easy cleaning**

The smooth surfaces and the closed frame profile avoid concrete adhesion to the greatest possible extent, and also make it easier to clean the elements.





## Lightweight

Low dead weight and only 5 panel widths

**DOMINO is the lightweight panelized formwork system with elements made of steel or aluminium for building construction and civil engineering projects. For easy distinction, the steel and aluminium elements are powder coated red and yellow respectively.**

The weight of the largest aluminum panel (250 cm x 100 cm) is less than 60 kg, and it can also be carried by two workers without the use of a crane.











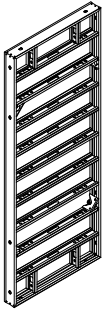
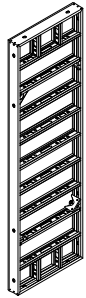

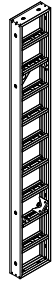
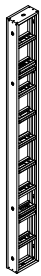
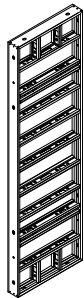
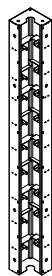
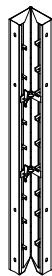

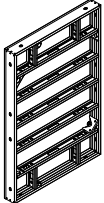
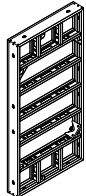

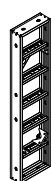

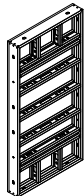



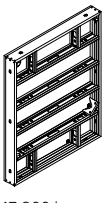
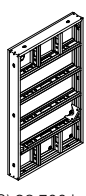

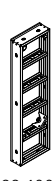
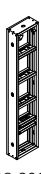
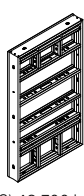
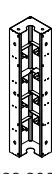
The selected DOMINO panel sizes are best suited to the frequently used small-scale applications.

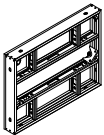
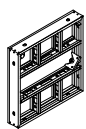
However, the lightweight DOMINO formwork elements also allow much larger dimensions. For concreting heights to 2.50, only two anchors are required – that means 1.25 m<sup>2</sup> wall surface per tie.

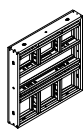

Aluminium elements are yellow powder-coated. As a result, they are easy to distinguish from the steel elements.



		Width								
		100	75	50	35	25	DM 75 Multi-Purpose Panel	DISE Internal Steel Corner	DGE Articulated Corner	DAW Outside Corner Angle
Height	250	 S) 87.700 kg A) 59.500 kg	 S) 71.600 kg A) 47.600 kg	 S) 54.500 kg	 S) 44.100 kg	 S) 37.700 kg	 S) 76.500 kg A) 50.200 kg	 S) 66.000 kg	 A) 40.600 kg	 A) 10.500 kg
	150	 S) 56.500 kg	 S) 46.100 kg	 S) 34.200 kg	 S) 26.900 kg	 S) 22.700 kg	 S) 51.300 kg	 S) 40.000 kg	 A) 23.700 kg	 A) 6.490 kg
	125	 S) 47.300 kg A) 31.000 kg	 S) 38.700 kg A) 24.800 kg	 S) 28.600 kg	 S) 22.400 kg	 S) 18.600 kg	 S) 43.700 kg A) 27.300 kg	 S) 33.300 kg	 A) 21.300 kg	 A) 5.490 kg
	75	 S) 32.400 kg	 S) 26.600 kg	 S) 19.300 kg	 S) 14.500 kg	 S) 12.100 kg	 S) 31.600 kg	 S) 20.500 kg	 A) 14.200 kg	 A) 3.500 kg

With 5 perfectly matched widths (25 cm, 35 cm, 50 cm, 75 cm and 100 cm) and 4 different standard element heights (75 cm, 125 cm, 150 cm and 250 cm), a wide range of formworking tasks can be accomplished.

- Key**
- A) Aluminium  
Panels with aluminium frames  
(yellow powder-coated)
  - S) Steel  
Panels with steel frames  
(red powder-coated)







## Simple

One component for virtually all connections – the Alignment Coupler DRS

**The Alignment Coupler DRS was designed specifically for the DOMINO system and has three advantages: the formwork elements are flush, aligned and tight in a single operation. The extremely accurate alignment thus provides the very best formwork results day after day.**

The Alignment Coupler DRS is used for standard panel joints, external and internal angles, acute and oblique angles, stopend formwork, timber compensations and extensions.

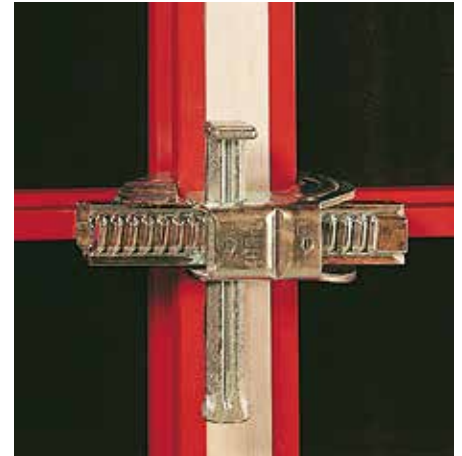
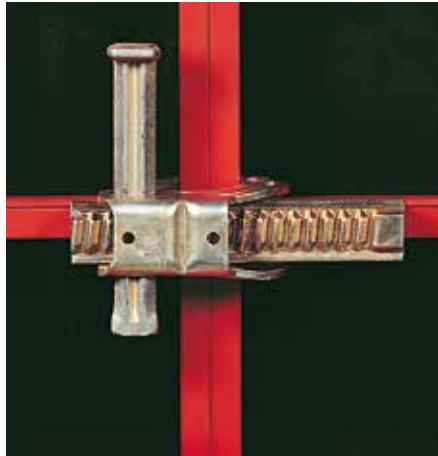

The Alignment Coupler DRS on a standard panel joint... .. and with timber compensations up to 10 cm thick.

Compensations with filler timber up to 10 cm are carried out with the Alignment Coupler only.

For compensations up to 12 cm, the supplementary Compensation Waler DAR takes over the bracing, aligning and force-transferring function.

Compensations up to 30 cm can be realised using the Filler Support DPA. The Compensation Waler DAR 80 transfers the anchor forces to the adjacent panels.

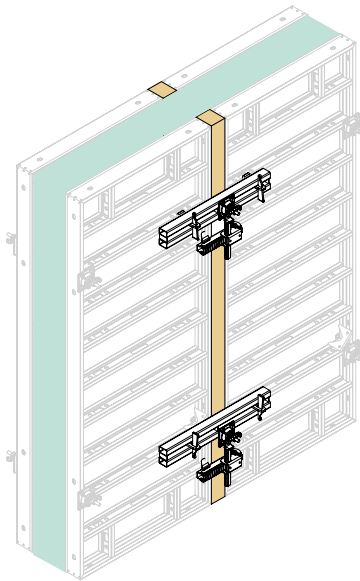

Up to 12 cm with DOMINO Alignment Coupler DRS and filler timber as well as 2 anchors in the Compensation Waler DAR 80.

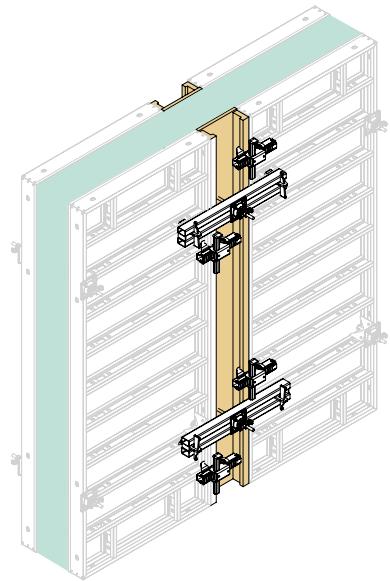

Up to 30 cm with Filler Support DPA as well as 2 anchors in the Compensation Waler DAR 80.

### DOMINO DKS Wedge Coupler

As an alternative, the Wedge Coupler can be used for panel connections without high loads in the foundations area.

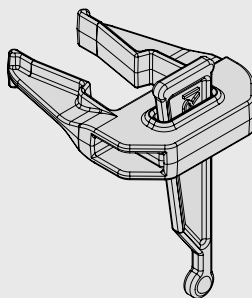

## Practical

Inset tie points and a comprehensive range of accessories for fast working operations in all situations

The tie points are inset so that the ties do not collide with water bars or dense reinforcement. All cross struts on the DOMINO panels have connecting holes for the wide range of available accessories.

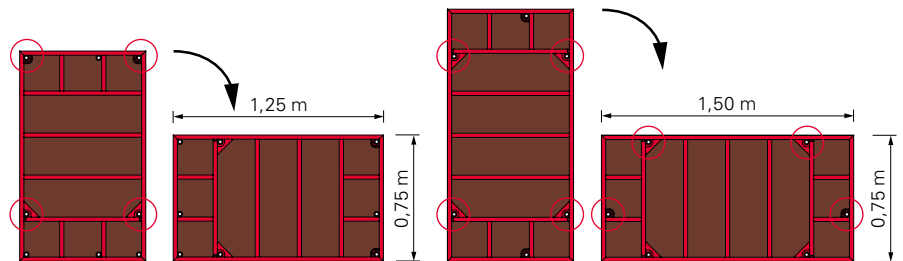

### Inset tie points

Thanks to the inset tie points, obstructions can be avoided without any problems. Thus, anchors positioned close to the ground are easy to install. As a

result, DOMINO is extremely suitable for forming foundations. Due to the inset tie points, the panels (125 cm, 150 cm) can be used in both a vertical and horizontal position.

### DOMINO Lifting Hook

The Lifting Hook can carry up to 500 kg. This allows the moving of large-sized vertically positioned panels or panel units. Always use 2 Lifting Hooks for each unit being moved.

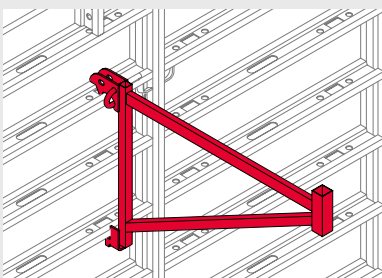
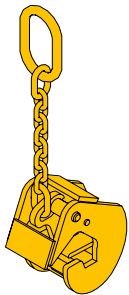

### DOMINO Scaffold Bracket

The Scaffold Bracket DG 85 for assembling an 85 cm wide concreting scaffold. The maximum bracket spacing is a cost-effective 2.00 m with an imposed load of 150 kg/m<sup>2</sup>. Planking and guardrails are installed in accordance with DIN 4420. The handrails are erected using handrail posts HSGP.

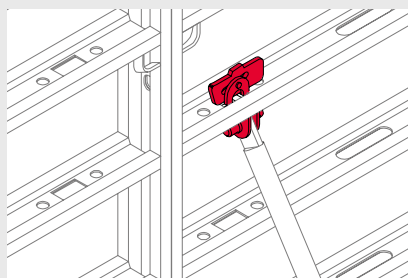

### DOMINO Brace Connector

The Brace Connector DRA is used for connecting push-pull props and kickers to horizontal and vertical struts.

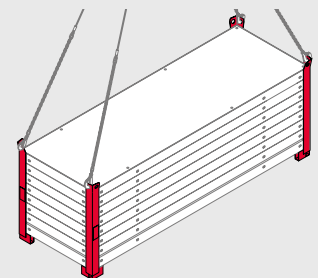

### DOMINO Stacking Device

For crane and forklift transport operations, a min. 2 and max. 8 panels are stacked using 4 stacking devices.



### Foundation Tie Clamp and Top Tie Bracket for strip foundations and single footings

The DOMINO Foundation Tie Clamp for easy shuttering of foundations, replacing the bottom tie position as well as saving work space and consequently earthmoving operations. Ties are tensioned accurately with a self-cleaning hexagonal spindle.

Using the top tie bracket for the top tie point avoids having to exactly position the DOMINO panels opposite each other. It is possible to tie at any position of the panel.

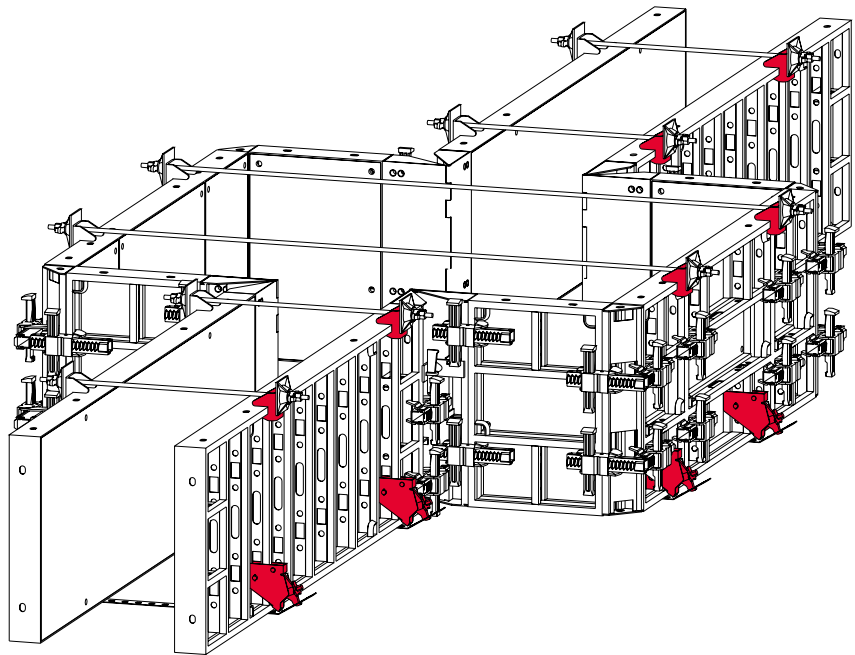

Foundation Tie Clamp DLS

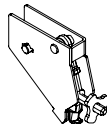

Perforated Foundation Tie

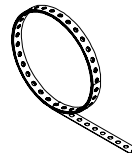

Top Tie Bracket DAH

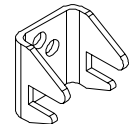

### High permissible concrete pressure

For concreting heights up to 2.50 m, DOMINO withstands the full hydrostatic pressure and conforms to DIN 18202, Table 3 line 7 (steel panels) and line 6 (aluminium panels). For greater heights, a fresh concrete pressure of 60 kN/m<sup>2</sup> for steel panels is permissible in compliance with DIN 18202, Table 3 Line 6. This allows fast concreting and ensures extremely flat concrete surfaces.

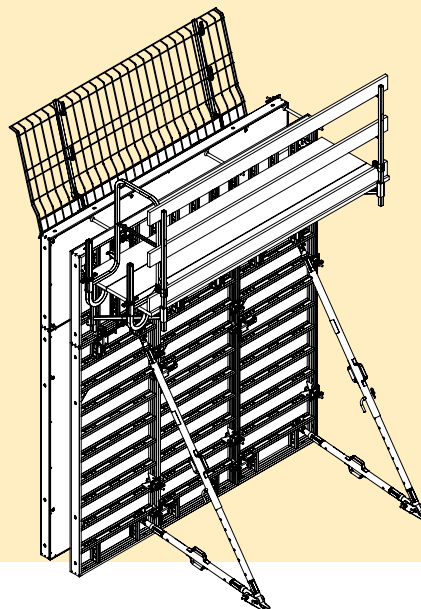

DOMINO formwork with push-pull props and concreting scaffold ready for use.

# DOMINO standard applications

Corners, T-junctions and fillers can easily be realised within the system

**Corners and T-junctions can be realised with DOMINO system components. Here, too, the principle applies that all site-relevant situations can be accomplished using as few additional components as possible.**

Two 50-sized panels, an Outside Corner Angle and a 90° Inside Steel Corner are all the elements that are required for

forming a right-angled corner. Angles from 75° to 165° can be realised using the articulated corner.

T-junctions can usually be formed with one 75-sized panel and two Inside Steel Corners or alternatively by means of two Articulated Corners. Together with the Wall Thickness Compensator, wall thicknesses of 15 cm to 35 cm are possible in 5 cm increments. Other

intermediate dimensions that are not covered by the DOMINO system can be accurately shuttered with longitudinal compensations.

Tight, aligned and flush connections are guaranteed using the Alignment Coupler DRS for longer longitudinal compensations in connection with Compensation Walers.

## Basic rules for right-angled corners

### External formwork

Panel D 50, Corner Angle DAW.

### Internal formwork

Inside Steel Corner DISE, adjusted to suit the wall thickness with Compensator DWD or timber.

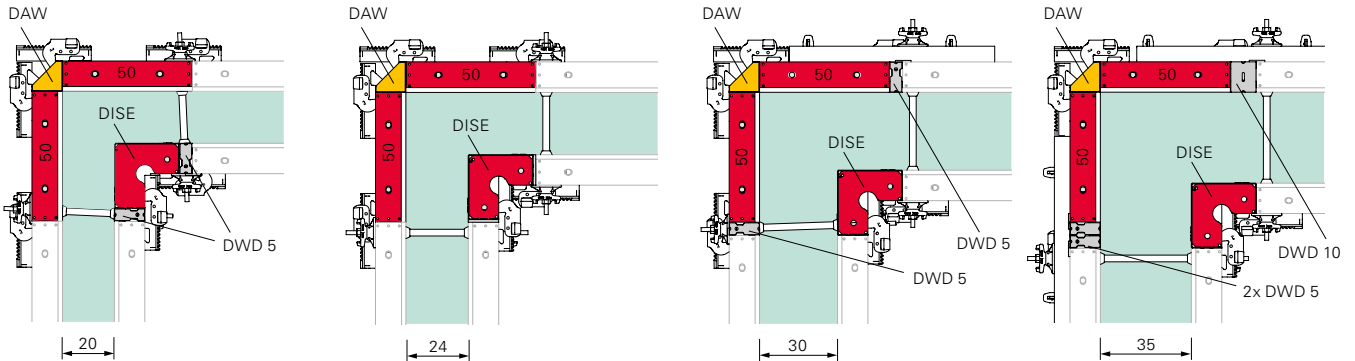

## Basic rules for T-Junctions

### External formwork

Panel D 75.

### Internal formwork

Inside Steel Corner DISE, adjusted to suit the wall thickness with Compensator DWD or timber.

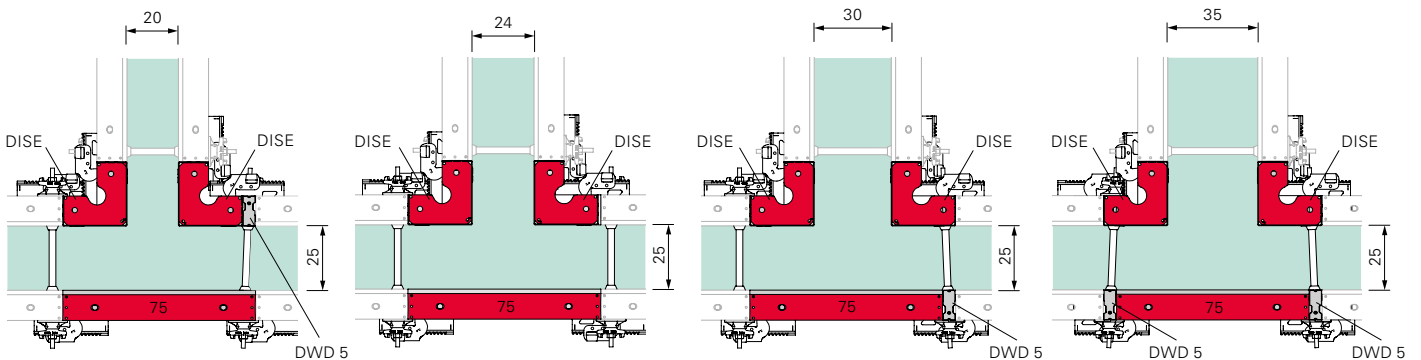



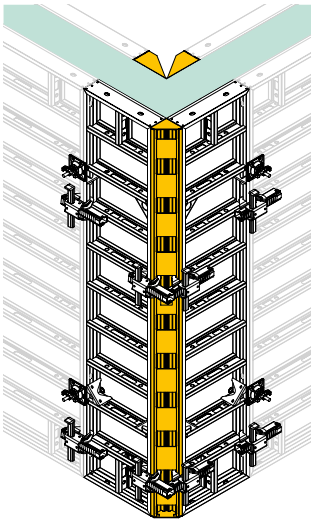

On the external corners, 2 Alignment Couplers DRS are required per side for heights of 2.50 m.

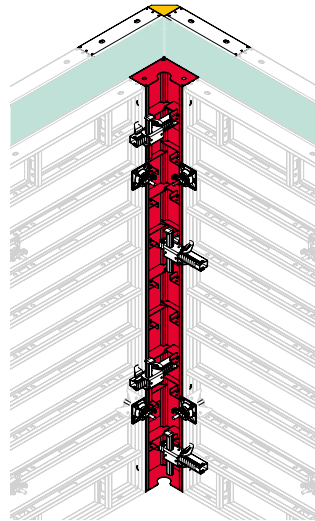

On the internal corners and standard panel joints, 2 Alignment Couplers DRS are required for heights of 2.50 m.

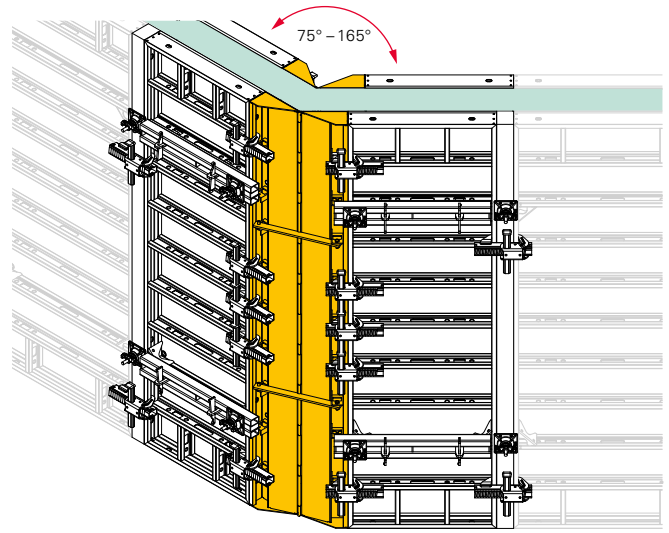

With the articulated corners, angles from 75° to 165° can be achieved.



### DOMINO Stopped Panel

AT/MTF with continuous reinforcement, with or without water stops:

- Time savings min. 40%
- No damage to the formlining

The rubber lip allows a continuous reinforcement thickness of max. 16 mm.

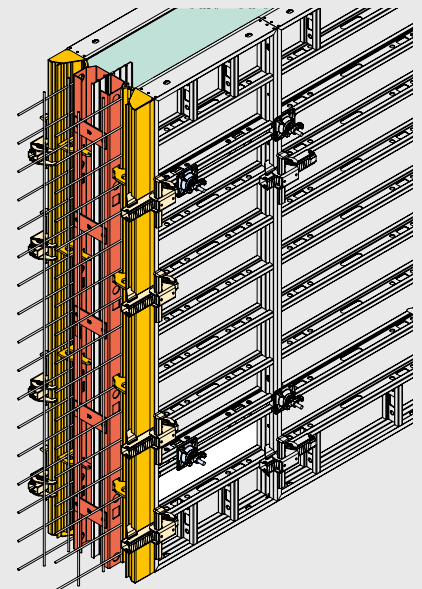
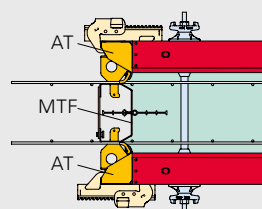
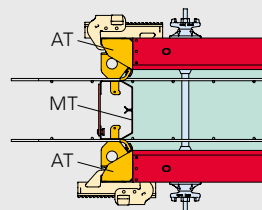







**The optimal System  
for every Project and  
every Requirement**



**Wall Formwork**



**Column Formwork**



**Slab Formwork**



**Climbing Systems**



**Bridge Formwork**



**Tunnel Formwork**



**Shoring Systems**



**Construction Scaffold**



**Facade Scaffold**



**Industrial Scaffold**



**Access**



**Protection Scaffold**



**Safety Systems**



**System-Independent  
Accessories**



**Services**



**PERI GmbH**  
**Formwork Scaffolding Engineering**  
 Rudolf-Diesel-Strasse 19  
 89264 Weissenhorn  
 Germany  
 Tel. +49 (0)7309.950-0  
 Fax +49 (0)7309.951-0  
 info@peri.com  
 www.peri.com

